

GALVANIZED PIPE AND Accessories



ECCO™ is proud to be a member of:



SMACNA
Sheet Metal and Air
Conditioning Contractors'
National Association
www.smacna.org



HRAI
Heating, Refrigeration and
Air Conditioning
Institute of Canada
www.hrai.ca



HARDI
Heating, Air-conditioning
& Refrigeration
Distributors International
www.hardinet.org



ADI
Air
Distribution
Institute
www.steelduct.org



AD
Affiliated Distributors™
www.adhq.com



CME
Canadian
Manufacturers &
Exporters
www.cme-mec.ca



SPIDA
Spiral Duct
Manufacturers
Association
www.spida.org



GALVANIZED PIPE AND ACCESSORIES

INDEX

CONDUCTOR PIPE.....	A3-5	PIPE REDUCERS	
DRAW BANDS — 24 GAUGE.....	A3-14	LARGE END/LARGE END — CENTERLINE (C/L REDUCERS	
FLEX CONNECTORS — 26 GAUGE.....	A3-14	L/E - L/E).....	A3-10
OVAL END CAPS.....	A3-6	LARGE END/LARGE END — (C/L REDUCERS	
OVAL PIPE — 26 GAUGE.....	A3-5	L/E-L/E).....	A3-7 – A3-8
PIPE — SNAP LOCK		LARGE END/SMALL END (C/L).....	A3-8
24 GAUGE.....	A3-5	LARGE END/SMALL END — STRAIGHT ONE SIDE (S1S	
26 GAUGE.....	A3-4	REDUCERS L/E - S/E).....	A3-10
28 GAUGE.....	A3-4	SMALL END/SMALL END — CENTERLINE	
30 GAUGE.....	A3-3	(C/L REDUCERS S/E - S/E).....	A3-11
LIGHT GAUGE RESIDENTIAL.....	A3-3	SMALL END/SMALL END (C/L).....	A3-8
PIPE DAMPERS		SMALL END/SMALL END — STRAIGHT ONE SIDE (S1S	
DUAL STEM.....	A3-12	REDUCERS S/E - S/E).....	A3-9
GALVANIZED — HEAVY GAUGE.....	A3-12	PLUGS — CRIMPED — GALVANIZED.....	A3-13
SINGLE STEM.....	A3-12	PLUGS/TEE CAPS	
PIPE INCREASERS		FABRICATED.....	A3-13
26 GAUGE.....	A3-7	SPUN.....	A3-13
GALVANIZED SHORT.....	A3-7	WALL STACKS — OVAL.....	A3-6
SPUN GALVANIZED.....	A3-6		

LEGEND

NOTE: The boxed columns throughout the tables are intended to provide a quick determination of ordering dimensions.

ABBREVIATIONS: CTN/QTY = Carton Quantity
 WT/100 = Weight per 100 Pieces
 WT/100 FT = Weight per 100 Feet
 FT/BNDL = Feet per Bundle

LIGHT GAUGE RESIDENTIAL PIPE — SNAP LOCK

ITEM #	SIZE (")	A (")	B (")	FT/BNDL	WT/100 FT
110470	4 × 60	4	60	50	48
110570	5 × 60	5	60	75	59
110670	6 × 60	6	60	50	73
110571	5 × 101	5	101	*	59
110472	4 × 120	4	120	50	48
110572	5 × 120	5	120	50	59
110573	5 × 36	5	36	30	59
110672	6 × 120	6	120	50	73

*5 Lengths/Bndl

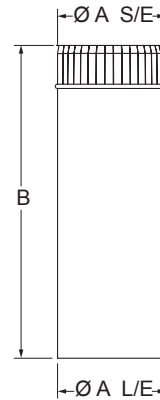

30 GAUGE PIPE — SNAP LOCK

ITEM #	SIZE (")	A (")	B (")	FT/BNDL	WT/100 FT
110324	3 × 24	3	24	20	50
110424	4 × 24	4	24	20	64
110524	5 × 24	5	24	50	78
110624	6 × 24	6	24	50	92
110724	7 × 24	7	24	50	106
110824	8 × 24	8	24	50	119
111024	10 × 24	10	24	50	186
111224	12 × 24	12	24	50	216
111236	12 × 36	12	36	30	205
110336	3 × 36	3	36	30	50
110436	4 × 36	4	36	30	64
110536	5 × 36	5	36	30	78
110636	6 × 36	6	36	30	92
110736	7 × 36	7	36	30	106
110836	8 × 36	8	36	30	119
110936	9 × 36	9	36	30	142
111036	10 × 36	10	36	30	176
110360	3 × 60	3	60	25	50
110460	4 × 60	4	60	50	64
110560	5 × 60	5	60	50	78
110660	6 × 60	6	60	50	92
110760	7 × 60	7	60	50	106
110860	8 × 60	8	60	50	119
110960	9 × 60	9	60	50	142
111060	10 × 60	10	60	25	176
111260	12 × 60	12	60	25	205
111460	14 × 60	13-15/16	60	25	238
110312	3 × 120	3	120	50	50
110412	4 × 120	4	120	50	64
110512	5 × 120	5	120	50	78
110612	6 × 120	6	120	50	92
110712	7 × 120	7	120	50	106
110812	8 × 120	8	120	50	119

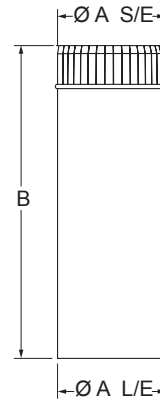

– E.&O.E. – Subject to Change Without Notice – May Not Be Available At All Locations –

28 GAUGE PIPE — SNAP LOCK

ITEM #	SIZE (")	A (")	B (")	FT/BNDL	WT/100 FT
110423	4 x 24	4	24	10	88
110303	3 x 36	3	36	15	70
110403	4 x 36	4	36	15	88
110503	5 x 36	5	36	30	108
110603	6 x 36	6	36	30	128
110703	7 x 36	7	36	30	147
110803	8 x 36	8	36	30	166
110443	4 x 48	4	48	20	88
110543	5 x 48	5	48	40	108
110643	6 x 48	6	48	40	128
110743	7 x 48	7	48	40	147
110843	8 x 48	8	48	40	166
110463	4 x 60	4	60	20	88
110563	5 x 60	5	60	50	108
110663	6 x 60	6	60	50	128
110763	7 x 60	7	60	25	147
110863	8 x 60	8	60	25	166
110963	9 x 60	9	60	25	186

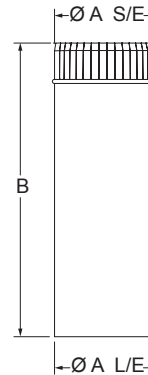

ITEM #	SIZE (")	A (")	B (")	FT/BNDL	WT/100 FT
111063	10 x 60	10	60	25	206
111263	12 x 60	12	60	25	244
111463	14 x 60	13-15/16	60	25	283

26 GAUGE PIPE — SNAP LOCK

ITEM #	SIZE (")	A (")	B (")	FT/BNDL	WT/100 FT
530316	3 x 24	3	24	10	81
530416	4 x 24	4	24	10	103
530516	5 x 24	5	24	20	126
530616	6 x 24	6	24	20	148
530716	7 x 24	7	24	20	170
530816	8 x 24	8	24	20	193
531016	10 x 24	10	24	20	252
531216	12 x 24	12	24	20	300
531416	14 x 24	13-15/16	24	20	346
531616	16 x 24	15-15/16	24	20	395
531816	18 x 24	17-7/8	24	20	440
530326	3 x 36	3	36	15	81
530426	4 x 36	4	36	15	103
530526	5 x 36	5	36	30	126
530626	6 x 36	6	36	30	148
530726	7 x 36	7	36	30	170
530826	8 x 36	8	36	30	193
530926	9 x 36	9	36	30	215
531026	10 x 36	10	36	30	239
531126	11 x 36	11	36	30	260
531226	12 x 36	12	36	30	284
531326	13 x 36	12-15/16	36	30	305
531426	14 x 36	13-15/16	36	30	328
531626	16 x 36	15-15/16	36	30	375
531818	18 x 36	17-7/8	36	30	530
530844	8 x 48	8	48	20	193
530944	9 x 48	9	48	20	215
531044	10 x 48	10	48	20	239
531244	12 x 48	12	48	20	284
531444	14 x 48	13-15/16	48	20	328
531648	16 x 48	15-15/16	48	20	380
531848	18 x 48	17-7/8	48	20	428

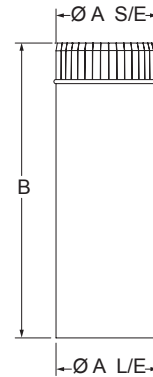

ITEM #	SIZE (")	A (")	B (")	FT/BNDL	WT/100 FT
532048	20 x 48	19-7/8	48	20	474
530360	3 x 60	3	60	25	81
530460	4 x 60	4	60	25	103
530560	5 x 60	5	60	25	126
530660	6 x 60	6	60	25	148
530760	7 x 60	7	60	25	170
530860	8 x 60	8	60	25	193
530960	9 x 60	9	60	25	215
531060	10 x 60	10	60	25	239
531260	12 x 60	12	60	25	284
531460	14 x 60	13-15/16	60	25	328
531660	16 x 60	15-15/16	60	25	380
531860	18 x 60	17-7/8	60	25	428
532060	20 x 60	19-7/8	60	25	474
530486	4 x 120	4	120	50	103
530586	5 x 120	5	120	50	126
530686	6 x 120	6	120	50	148
530786	7 x 120	7	120	50	170
530886	8 x 120	8	120	50	193

- E.&O.E. - Subject to Change Without Notice - May Not Be Available At All Locations -

24 GAUGE PIPE — SNAP LOCK

ITEM #	SIZE (")	A (")	B (")	FT/BNDL	WT/100 FT
530514	5 × 24	5	24	20	160
530614	6 × 24	6	24	20	189
530714	7 × 24	7	24	20	217
530814	8 × 24	8	24	20	246
530914	9 × 24	9	24	20	275
531014	10 × 24	10	24	20	305
531214	12 × 24	12	24	20	362
531414	14 × 24	13-15/16	24	20	419
530524	5 × 36	5	36	30	160
530624	6 × 36	6	36	30	189
530724	7 × 36	7	36	30	217
530824	8 × 36	8	36	30	246
530924	9 × 36	9	36	30	289
531024	10 × 36	10	36	30	305
531224	12 × 36	12	36	30	362
531424	14 × 36	13-15/16	36	30	419
531824	18 × 36	17-7/8	36	30	554
531644	16 × 48	15-15/16	48	20	485
531844	18 × 48	17-7/8	48	20	540
532044	20 × 48	19-7/8	48	20	605
530554	5 × 60	5	60	25	160
530654	6 × 60	6	60	25	189

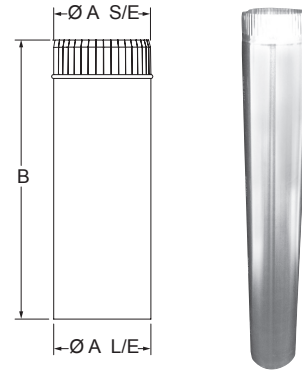

ITEM #	SIZE (")	A (")	B (")	FT/BNDL	WT/100 FT
530754	7 × 60	7	60	25	217
530854	8 × 60	8	60	25	246
530954	9 × 60	9	60	25	275
531054	10 × 60	10	60	25	305
531254	12 × 60	12	60	25	362
531454	14 × 60	13-15/16	60	25	419
531654	16 × 60	15-15/16	60	25	485
531854	18 × 60	17-7/8	60	25	540
532054	20 × 60	19-7/8	60	25	605

NOTE: 22 gauge and heavier pipe available upon request.

CONDUCTOR PIPE

ITEM #	SIZE (")	A (")	B (")	FT/BNDL	WT/100 FT
532104	4 × 120	4	120	*	86
532105	5 × 120	5	120	*	105
532106	6 × 120	6	120	*	125
532107	7 × 120	7	120	*	145
532108	8 × 120	8	120	*	165

*Product shipped individually.

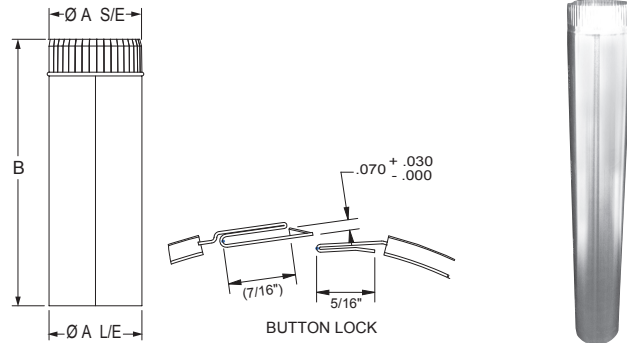

OVAL PIPE — 26 GAUGE

ITEM #	SIZE (")	A (")	B (")	C (")	FT/BNDL	WT/100 FT
532160	6 - (3 × 7-3/4) × 96	3	7-3/4	96	40	156
532170	7 - (3 × 9-1/4) × 96	3	9-1/4	96	40	180
532180	8 - (3 × 10-7/8) × 96	3	10-7/8	96	40	203

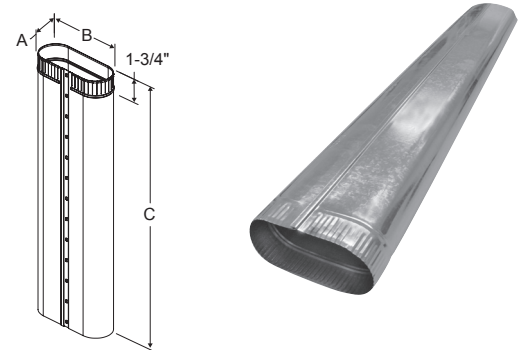

-E.&O.E. - Subject to Change Without Notice - May Not Be Available At All Locations -

WALL STACKS — OVAL

ITEM #	SIZE	A (")	B (")	C (")	FT/BNDL	WT/100 FT
111840	4 - (3 × 4-9/16) × 96	3	4-9/16	96	40	68
111648	5 - (3 × 6-1/8) × 60	3	6-1/8	60	25	80
111852	5 - (3 × 6-1/8) × 52	3	6-1/8	52	*	338
111854	5 - (3 × 6-1/8) × 100	3	6-1/8	100	*	650
111652	6 - (3 × 7-3/4) × 52	3	7-3/4	52	*	399
111658	6 - (3 × 7-3/4) × 60	3	7-3/4	60	25	92
111660	6 - (3 × 7-3/4) × 96	3	7-3/4	96	40	92
111661	6 - (3 × 7-3/4) × 100	3	7-3/4	100	*	780
111662	6 - (3 × 7-3/4) × 102	3	7-3/4	102	*	782
111663	6 - (3 × 7-3/4) × 104	3	7-3/4	104	*	836
111664	6 - (3 × 7-3/4) × 114	3	7-3/4	114	*	873
111665	6 - (3 × 7-3/4) × 120	3	7-3/4	120	*	918
111668	7 - (3 × 9-1/4) × 60	3	9-1/4	60	25	106
111670	7 - (3 × 9-1/4) × 96	3	9-1/4	96	40	106
111672	7 - (3 × 9-1/4) × 102	3	9-1/4	102	*	959
111675	7 - (3 × 9-1/4) × 120	3	9-1/4	120	*	1128
111678	8 - (3 × 10-7/8) × 60	3	10-7/8	60	25	119
111680	8 - (3 × 10-7/8) × 96	3	10-7/8	96	40	119
111682	8 - (3 × 10-7/8) × 102	3	10-7/8	102	*	1249
111685	8 - (3 × 10-7/8) × 120	3	10-7/8	120	*	1469

*5 Lengths/Bndl

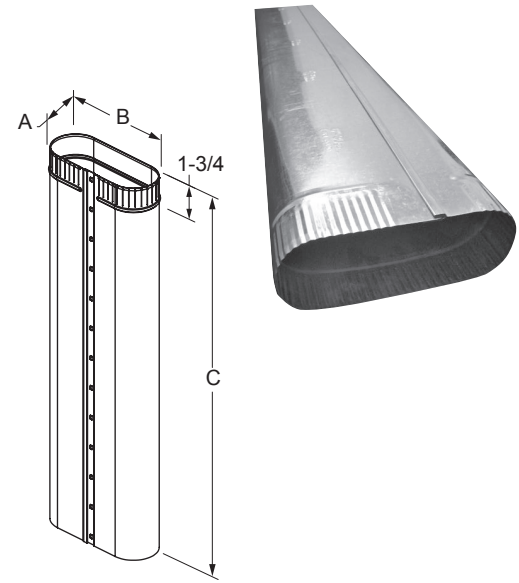

OVAL END CAPS

ITEM #	SIZE	A (")	B (")	CTN/QTY	WT/100
111804	4 - (3 × 4-5/8)	3	4-5/8	20	15
111805	5 - (3 × 6-1/8)	3	6-1/8	20	20
111806	6 - (3 × 7-3/4)	3	7-3/4	20	20
111807	7 - (3 × 9-1/4)	3	9-1/4	20	25
111808	8 - (3 × 10-7/8)	3	10-7/8	20	30

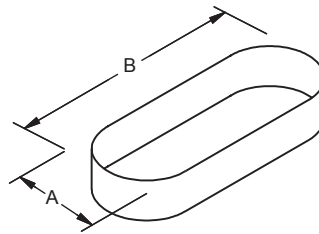

PIPE INCREASERS — SPUN GALVANIZED

ITEM #	SIZE (")	A (")	B (")	CTN/QTY	WT/100
136210	3 - 4	3	4	20	25
136212	3 - 5	3	5	20	30
136214	3 - 6	3	6	20	40
136216	3 - 7	3	7	10	50
136213	4 - 5	4	5	20	32
136217	4 - 6	4	6	20	42
136219	4 - 7	4	7	10	50
136218	5 - 6	5	6	20	40
136220	5 - 7	5	7	10	55
136222	6 - 7	6	7	10	53
136226	6 - 8	6	8	10	66
136227	7 - 8	7	8	10	60

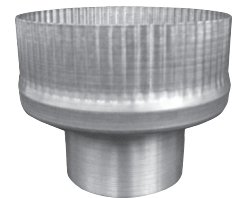
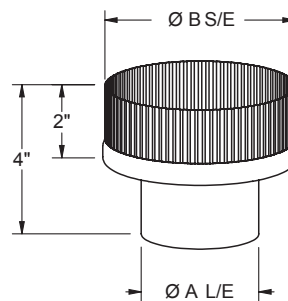

-E.&O.E. - Subject to Change Without Notice - May Not Be Available At All Locations -

PIPE INCREASERS — GALVANIZED SHORT

ITEM #	SIZE (")	A (")	B (")	CTN/QTY	WT/100
136230	3-4	3	4	50	21
136231	3-5	3	5	50	26
136233	4-5	4	5	50	26
136234	4-6	4	6	50	32
136236	5-6	5	6	50	32

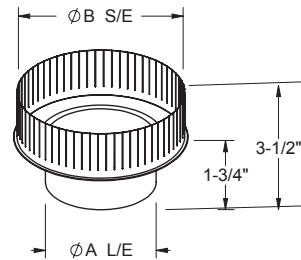

PIPE INCREASERS — 26 GAUGE

ITEM #	SIZE (")	A (")	B (")	C (")	GA	CTN/QTY	WT/100
526526	3-4	3	4	7-1/2	26	20	60
526426	3-5	3	5	8-1/2	26	20	85
526326	4-5	4	5	7-1/2	26	20	85
526226	4-6	4	6	8-1/2	26	20	90
526026	5-6	5	6	7-1/2	26	20	100

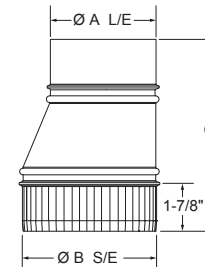

PIPE REDUCERS — LARGE END/LARGE END — (C/L REDUCERS L/E-L/E)

ITEM #	SIZE (")	A (")	B (")	C (")	GA	CTN/QTY	WT/100
136460	4-3	4	3	4-5/8	30	20	40
136461	5-3	5	3	5-5/8	30	20	45
136462	5-4	5	4	4-5/8	30	20	45
136464	6-4	6	4	5-5/8	30	20	50
136465	6-5	6	5	4-5/8	30	20	50
136468	7-5	7	5	5-5/8	30	20	60
136469	7-6	7	6	4-5/8	30	20	60
136472	8-5	8	5	6-5/8	30	20	75
136473	8-6	8	6	5-5/8	30	20	75
136474	8-7	8	7	4-5/8	30	20	75
136343	4-3	4	3	4-5/8	26	20	52
136353	5-3	5	3	5-5/8	26	20	58
136354	5-4	5	4	4-5/8	26	20	58
136363	6-3	6	3	6-5/8	26	20	65
136364	6-4	6	4	5-5/8	26	20	65
136365	6-5	6	5	4-5/8	26	20	65
136374	7-4	7	4	6-5/8	26	20	78
136375	7-5	7	5	5-5/8	26	20	78
136376	7-6	7	6	4-5/8	26	20	78
136384	8-4	8	4	7-1/2	26	20	130
136385	8-5	8	5	6-5/8	26	20	126
136386	8-6	8	6	5-5/8	26	20	122
136387	8-7	8	7	4-5/8	26	20	118
136396	9-6	9	6	6-5/8	26	20	170
136397	9-7	9	7	5-5/8	26	20	160
136398	9-8	9	8	4-5/8	26	20	155
136406	10-6	10	6	7-1/2	26	20	191
136407	10-7	10	7	6-5/8	26	20	194

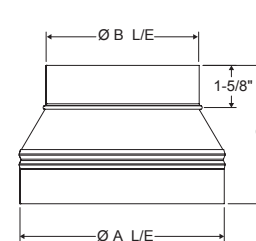

(cont'd on next page)

-E.&O.E. - Subject to Change Without Notice - May Not Be Available At All Locations -

PIPE REDUCERS — LARGE END/LARGE END — (C/L REDUCERS L/E-L/E) (cont'd)

ITEM #	SIZE (")	A (")	B (")	C (")	GA	CTN/QTY	WT/100
136408	10 - 8	10	8	5-5/8	26	20	188
136409	10 - 9	10	9	4-5/8	26	20	177
136417	12 - 7	12	7	7-1/2	26	20	280
136418	12 - 8	12	8	7-1/2	26	20	272
136419	12 - 9	12	9	6-5/8	26	20	256
136420	12 - 10	12	10	5-5/8	26	20	237
136428	14 - 8	13-15/16	8	9-1/2	26	20	180
136430	14 - 10	13-15/16	10	7-1/2	26	20	280
136432	14 - 12	13-15/16	12	5-5/8	26	20	255
136440	16 - 10	15-15/16	10	9-1/2	26	*	230
136442	16 - 12	15-15/16	12	7-1/2	26	*	410
136444	16 - 14	15-15/16	13-15/16	5-5/8	26	*	290
136452	18 - 12	17-7/8	12	9-1/2	26	*	290
136454	18 - 14	17-7/8	13-15/16	7-1/2	26	*	250
136456	18 - 16	17-7/8	15-15/16	5-5/8	26	*	330
136458	20 - 18	20	18	5-5/8	26	*	306

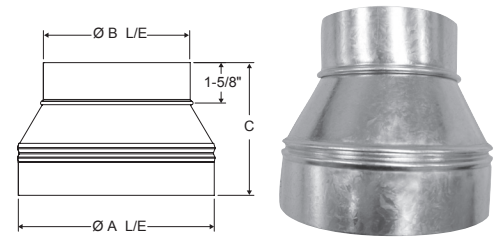

*Product shipped individually.

PIPE REDUCERS — LARGE END/SMALL END (C/L)

ITEM #	SIZE (")	A (")	B (")	C (")	GA	CTN/QTY	WT/100
136240	6 - 4	6	4	3	28	20	40
136247	8 - 6	8	6	3	28	20	50
136250	10 - 6	10	6	3	28	20	60
136252	10 - 8	10	8	3	28	20	60
136256	12 - 8	12	8	3	28	20	70
136258	12 - 10	12	10	2-3/4	28	20	70
136325	7 - 5	7	5	2	26	20	70
136260	10 - 8	10	8	6-1/2	26	20	100

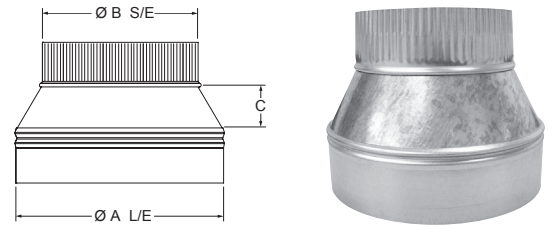

PIPE REDUCERS — SMALL END/SMALL END (C/L)

ITEM #	SIZE (")	A (")	B (")	GA	CTN/QTY	WT/100
136270	5 - 4	5	4	26	20	50
136275	7 - 5	7	5	26	20	70
136287	8 - 7	8	7	26	20	80

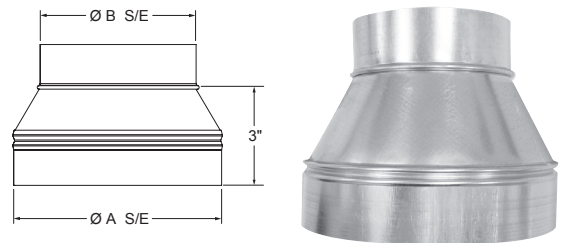

-E.&O.E. - Subject to Change Without Notice - May Not Be Available At All Locations -



GALVANIZED PIPE AND ACCESSORIES

PIPE REDUCERS — SMALL END/SMALL END — STRAIGHT ONE SIDE (S1S REDUCERS S/E - S/E)

ITEM #	SIZE (")	A (")	B (")	C (")	GA	CTN/QTY	WT/100
510107	4-3	4	3	7-3/8	28	20	80
510106	5-3	5	3	8-1/2	28	20	100
510104	5-4	5	4	7-5/8	28	20	100
510102	6-4	6	4	8-1/2	28	20	110
510101	6-5	6	5	7-3/8	28	20	100
510098	7-5	7	5	8-1/2	28	10	140
510097	7-6	7	6	7-1/4	28	10	130
510095	8-4	8	4	13	28	10	160
510094	8-5	8	5	10-3/4	28	10	170
510093	8-6	8	6	8-5/8	28	10	160
510092	8-7	8	7	7-1/2	28	10	150
510088	9-6	9	6	10-3/4	28	10	180
510087	9-7	9	7	8-5/8	28	10	205
510086	9-8	9	8	7-5/8	28	10	200
510082	10-6	10	6	13	28	10	200
510081	10-7	10	7	10-3/4	28	10	210
510080	10-8	10	8	8-1/2	28	10	199
510075	10-9	10	9	7-3/4	28	10	199
510070	12-8	12	8	13	28	10	309
510065	12-9	12	9	10-3/4	28	10	312
510060	12-10	12	10	8-1/2	28	10	312
510057	14-8	13-15/16	8	17	28	10	300
510055	14-10	13-15/16	10	13	28	10	311
510050	14-12	13-15/16	12	8-3/4	28	10	340
510047	16-10	15-15/16	10	17-3/8	28	*	400
510045	16-12	15-15/16	12	13	26	*	539
510040	16-14	15-15/16	13-15/16	8-3/4	26	*	507
510037	18-12	17-7/8	12	17-3/8	26	*	500
510035	18-14	17-7/8	13-15/16	13-1/8	26	*	920
510030	18-16	17-7/8	15-15/16	8-7/8	26	*	932
510027	20-14	19-7/8	13-15/16	17-1/2	24	*	600
510025	20-16	19-7/8	15-15/16	13-1/8	24	*	998
510020	20-18	19-7/8	17-7/8	8-3/4	24	*	829
510017	22-16	21-7/8	15-15/16	17-3/8	24	*	700
510015	22-18	21-7/8	17-7/8	12-7/8	24	*	1116
510010	22-20	21-7/8	19-7/8	8-1/2	24	*	948
510007	24-18	23-7/8	17-7/8	17-1/8	24	*	800
510005	24-20	23-7/8	19-7/8	12-3/4	24	*	1192
510000	24-22	23-7/8	21-7/8	8-1/2	24	*	1058

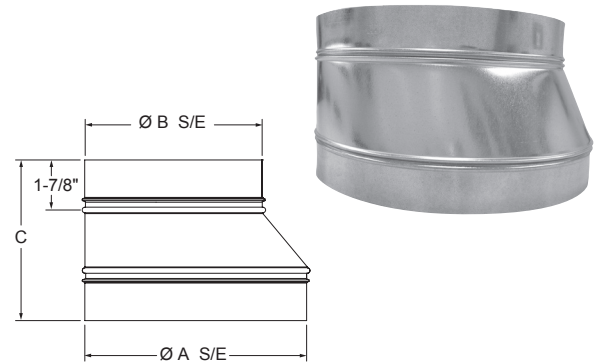

*Product shipped individually.

-E.&O.E. - Subject to Change Without Notice - May Not Be Available At All Locations -

PIPE REDUCERS — LARGE END/LARGE END — CENTERLINE (C/L REDUCERS L/E - L/E)

ITEM #	SIZE (")	A (")	B (")	C (")	GA	CTN/QTY	WT/100
511104	5 - 4	5	4	4-5/8	24	20	75
511102	6 - 4	6	4	5-5/8	24	20	84
511101	6 - 5	6	5	4-5/8	24	20	84
511098	7 - 5	7	5	5-5/8	24	20	100
511097	7 - 6	7	6	4-5/8	24	20	100
511093	8 - 6	8	6	5-5/8	24	20	152
511092	8 - 7	8	7	4-5/8	24	20	152

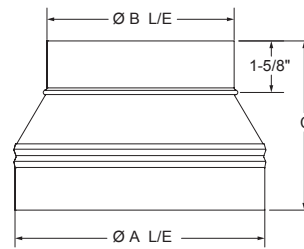

PIPE REDUCERS — LARGE END/SMALL END — STRAIGHT ONE SIDE (S1S REDUCERS L/E - S/E)

ITEM #	SIZE (")	A (")	B (")	C (")	GA	CTN/QTY	WT/100
523526	4 - 3	4	3	7-1/2	28	20	60
523426	5 - 3	5	3	8-1/2	28	20	60
523326	5 - 4	5	4	7-1/2	28	20	85
523126	6 - 4	6	4	8-1/2	28	20	110
523026	6 - 5	6	5	7-1/2	28	20	100
522926	7 - 5	7	5	8-1/2	28	10	140
522826	7 - 6	7	6	7-1/2	28	10	130
523226	8 - 4	8	4	12-3/4	28	10	190
522726	8 - 5	8	5	10-5/8	28	10	170
522626	8 - 6	8	6	8-1/2	28	10	160
522526	8 - 7	8	7	7-1/2	28	10	150
522326	9 - 6	9	6	10-5/8	28	10	179
522226	9 - 7	9	7	8-1/2	28	10	206
522126	9 - 8	9	8	6-1/2	28	10	201
522026	10 - 6	10	6	12-3/4	28	10	201
521926	10 - 7	10	7	10-5/8	28	10	210
521826	10 - 8	10	8	8-1/2	28	10	199
521726	10 - 9	10	9	6-1/2	28	10	191
521226	12 - 8	12	8	12-3/4	28	10	309
521126	12 - 9	12	9	10-5/8	28	10	312
521026	12 - 10	12	10	8-1/2	28	10	280
520626	14 - 8	13-15/16	8	17	28	10	300
520426	14 - 10	13-15/16	10	12-3/4	28	10	311
520226	14 - 12	13-15/16	12	8-1/2	28	10	340

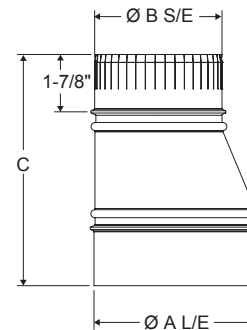

NOTE: For Spiral Pipe application, order S/E-S/E.

PIPE REDUCERS — SMALL END/SMALL END — CENTERLINE (C/L REDUCERS S/E - S/E)

ITEM #	SIZE (")	A (")	B (")	C (")	GA	CTN/QTY	WT/100
510178	8-6	8	6	5-1/4	26	20	98
510175	10-6	10	6	7-1/4	26	20	110
510173	10-8	10	8	5-1/4	26	20	124
510170	12-6	12	6	9	26	20	124
510168	12-8	12	8	7-1/4	26	20	138
510166	12-10	12	10	5-1/4	26	20	150
510163	14-8	13-15/16	8	9	26	20	152
510161	14-10	13-15/16	10	7-1/4	26	20	164
510160	14-12	13-15/16	12	5-1/4	26	20	178
510157	16-10	15-15/16	10	9	26	*	206
510156	16-12	15-15/16	12	7-1/4	26	*	222
510155	16-14	15-15/16	13-15/16	5-1/4	26	*	238
510152	18-12	17-7/8	12	9	26	*	240
510151	18-14	17-7/8	13-15/16	7-1/4	26	*	256
510150	18-16	17-7/8	15-15/16	5-1/4	26	*	270
510147	20-14	19-7/8	13-15/16	9	24	*	344
510146	20-16	19-7/8	15-15/16	7-1/4	24	*	364
510145	20-18	19-7/8	17-7/8	5-1/4	24	*	384
510142	22-16	21-7/8	15-15/16	9	24	*	384
510141	22-18	21-7/8	17-7/8	7-1/4	24	*	404
510140	22-20	21-7/8	19-7/8	5-1/4	24	*	424
510137	24-18	23-7/8	17-7/8	9	24	*	424
510136	24-20	23-7/8	19-7/8	7-1/4	24	*	444
510135	24-22	23-7/8	21-7/8	5-1/4	24	*	464
510132	26-20	25-7/8	19-7/8	9	22	*	566
510131	26-22	25-7/8	21-7/8	7-1/4	22	*	590
510130	26-24	25-7/8	23-7/8	5-1/4	22	*	614
510127	28-22	27-7/8	21-7/8	9	22	*	614
510126	28-24	27-7/8	23-7/8	7-1/4	22	*	638
510125	28-26	27-7/8	25-7/8	5-1/4	22	*	664
510122	30-24	29-7/8	23-7/8	9	22	*	662
510121	30-26	29-7/8	25-7/8	7-1/4	22	*	688
510120	30-28	29-7/8	27-7/8	5-1/4	22	*	712

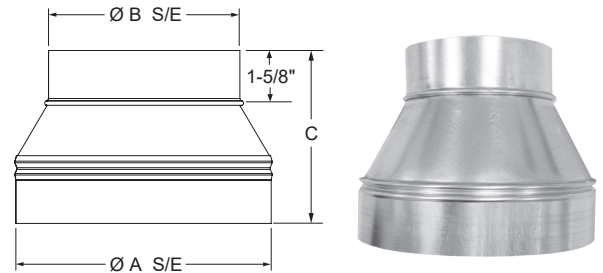

*Product shipped individually.

NOTE: Heavier gauges available upon request.

PIPE DAMPERS — SINGLE STEM

ITEM #	SIZE (")	A (")	CTN/QTY	WT/100
112600	3	2-11/16	50	10
112700	4	3-11/16	50	12
112800	5	4-11/16	50	16
112900	6	5-11/16	50	21
113000	7	6-11/16	50	27
113100	8	7-11/16	50	34

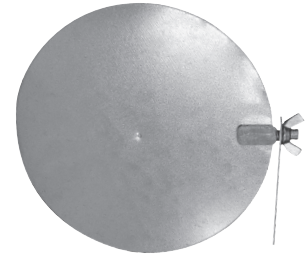
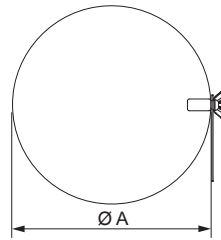

PIPE DAMPERS — DUAL STEM

ITEM #	SIZE (")	A (")	CTN/QTY	WT/100
114004	4	3-11/16	50	25
114005	5	4-11/16	50	31
114006	6	5-11/16	50	36
114007	7	6-11/16	50	43
114008	8	7-11/16	50	52
114009	9	8-11/16	50	60
114010	10	9-11/16	50	74
114012	12	11-11/16	30	122
114014	14	13-11/16	20	48
114016	16	15-11/16	25	56

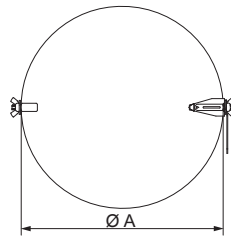

PIPE DAMPERS — GALVANIZED — HEAVY GAUGE

ITEM #	SIZE (")	A (")	GA	CTN/QTY	WT/100
575004	4	3-3/4	24	25	24
575005	5	4-3/4	24	25	30
575006	6	5-3/4	24	25	40
575007	7	6-3/4	24	25	46
575008	8	7-3/4	24	25	56
575009	9	8-3/4	24	25	82
575010	10	9-3/4	24	10	93
575012	12	11-3/4	24	10	106
575014	14	13-3/4	22	10	198
575016	16	15-3/4	22	*	243
575018	18	17-3/4	22	*	255
575020	20	19-3/4	20	*	350

NOTE: Hardware: 1 - Steel Rod
1 - Wing Nut
1 - Washer

*Product shipped individually.

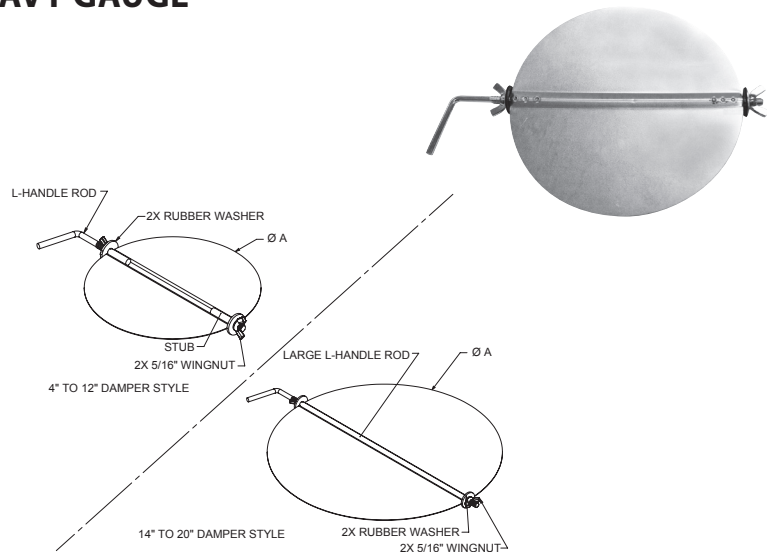

PLUGS — CRIMPED — GALVANIZED

ITEM #	SIZE (")	A (")	CTN/QTY	WT/100
136503	3	3	20	20
136504	4	4	20	25
136505	5	5	20	35
136506	6	6	20	22
136507	7	7	20	52
136508	8	8	20	73
136510	10	10	20	110
136512	12	12	10	90

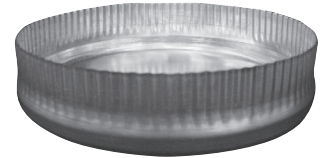
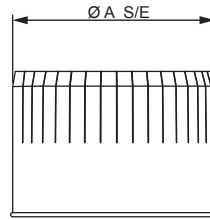

PLUGS/TEE CAPS — SPUN

ITEM #	SIZE (")	A (")	CTN/QTY	WT/100
570326	3	3	20	20
570426	4	4	20	26
570526	5	5	20	35
570626	6	6	20	46
570726	7	7	20	60
570826	8	8	20	72
570926	9	9	20	85
571026	10	10	20	101
571126	11	11	10	110
571226	12	12	10	140
571326	13	13	10	160
571426	14	14	10	184

ITEM #	SIZE (")	A (")	CTN/QTY	WT/100
571526	15	15	10	200
571626	16	16	10	226
571726	17	17	10	250
571826	18	18	10	270
572026	20	20	*	313
572226	22	22	*	370
572426	24	24	*	435
572626	26	26	*	490
572826	28	28	*	580
573026	30	30	*	655

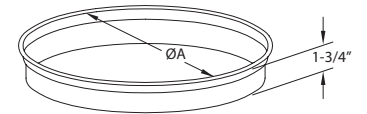

*Product shipped individually.

NOTE: Large end to fit over spiral pipe, + 1/8" (Cap). Small end to fit in spiral pipe, - 1/8" (Plug). Other sizes available upon request.

PLUGS/TEE CAPS — FABRICATED

ITEM #	SIZE (")	A (")	CTN/QTY	WT/100
573053	3	3	20	18
573054	4	4	20	28
573055	5	5	20	46
573056	6	6	20	63
573057	7	7	20	73
573058	8	8	20	105
573059	9	9	20	117
573060	10	10	20	129
573062	12	12	10	186
573064	14	14	10	215
573066	16	16	10	266
573068	18	18	10	321
573070	20	20	*	423

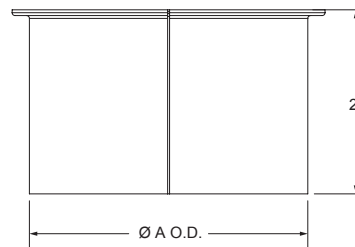

*Product shipped individually.



GALVANIZED PIPE AND ACCESSORIES

DRAW BANDS — 24 GAUGE

ITEM #	SIZE (")	A (")	CTN/QTY	WT/100
136524	4	4	50	90
136525	5	5	50	105
136526	6	6	50	120
136527	7	7	40	135
136528	8	8	25	150

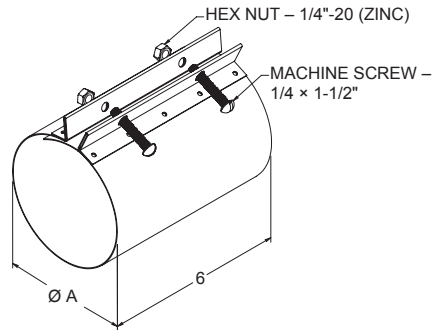

FLEX CONNECTORS — 26 GAUGE

ITEM #	SIZE (")	A (")	CTN/QTY	WT/100
133204	4	4	40	48
133205	5	5	40	60
133206	6	6	40	72
133207	7	7	20	84
133208	8	8	20	95
133209	9	9	20	107
133210	10	10	20	119
133212	12	12	10	143
133214	14	14	10	166
133216	16	16	5	190
133218	18	18	5	213

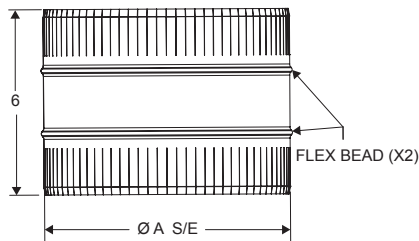

— E.&O.E. — Subject to Change Without Notice — May Not Be Available At All Locations —



www.eccomfg.com

Langley Distribution

19860 Fraser Highway
Langley, British Columbia
Canada V3A 4C9

Phone: 604-530-4151
Toll Free: 1-877-955-4805
Fax: 604-533-9335

Calgary Distribution

21 – 11150 38th Street, S.E.
Calgary, Alberta
Canada T2C 2Z6

Phone: 403-720-0895
Toll Free: 1-877-955-4815
Fax: 403-720-0897

Kent Distribution

20001 87th Ave. S, Bldg E
Kent, Washington
USA 98031

Phone: 253-872-3721
Toll Free: 1-800-207-6859
Fax: 253-872-3724